

## 4803C Conductivity/TDS 4-20mA Transmitter



### **Introduction:**

Thank you for choosing this Conductivity/TDS transmitter. This 1/16 DIN controller offers dual backlight LCD display, high accuracy, and automatic or manual temperature compensation.

### **Specifications:**

|              | <b>Conductivity</b>   | <b>TDS</b>   | <b>Temp.</b>      |
|--------------|---|--|-------------------|
| Range        | 0.0~ 199.9 $\mu$ S<br>200~ 1999 $\mu$ S<br>2.00~ 19.99 mS<br>20.0~ 100.0 mS | 0.0~131.9 ppm<br>132~1319 ppm<br>1.32~13.19 ppt<br>13.2~66.7.0 ppt | 0~110 °C          |
| Accuracy     | $\pm$ 2% FS   | $\pm$ 2% FS  | $\pm$ 0.2+1 digit |
| Resolution   | 0.1/1 $\mu$ S/0.01/0.1 mS   | 0.1/1ppm/0.01/0.1ppt   | 0.1 °C            |
| Compensation | ATC: 0~50 °C  | ATC: 0~50 °C   |                   |

|                          |   |
|--------------------------|---|
| Temperature Compensation | ATC (0-100°C) via 30K Thermistor or MTC |
| Output                   | 4-20mA isolated current output          |
| Signal output load       | 500 $\Omega$                            |
| Power supply             | 9V DC                                   |
| Panel Cutout             | 1/16th DIN 1.81 x 1.81" (46 x 46mm)     |
| Meter Dimensions         | 4.7 x 1.77 x 1.77" (105 x 45 x 45mm)    |

### **Accessories:**

9V DC/AC(100~240V) adaptor

Adapter connection wire

## Installation:

### <Mounting the controller>

1. Make a 1.77 x 1.77" (45 x 45 mm) panel cutout (1/8" to 3/8" thickness)
2. Slide the controller into the cutout until the bezel is flush with the panel.
3. Slide the mounting bracket over the rear of the controller and press snugly against the rear of the panel.



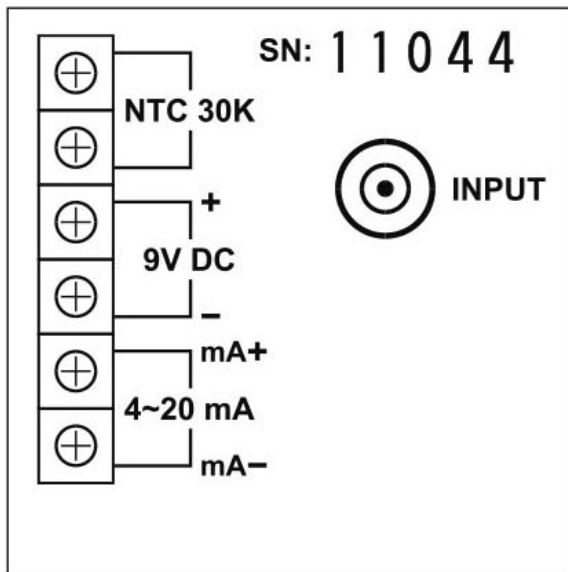

### <Rear panel connection>

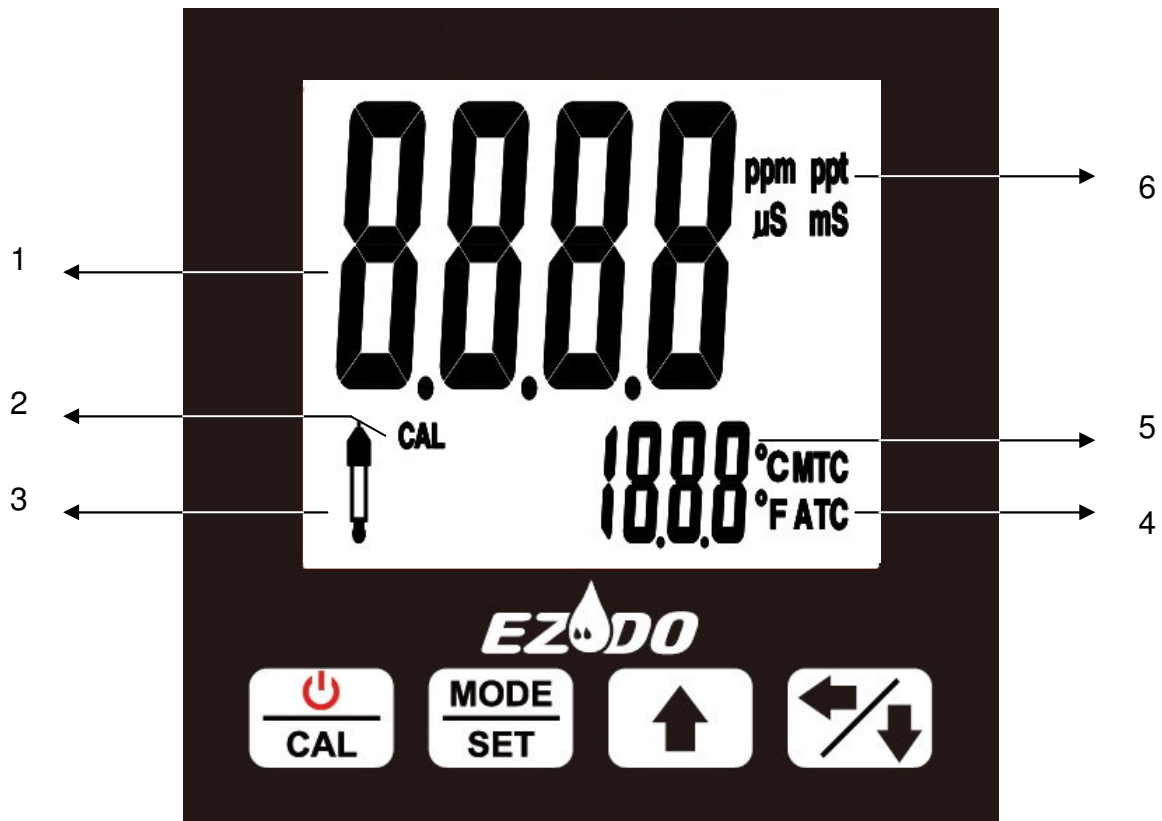

<Display and Buttons>



1. Conductivity or TDS reading
2. Calibration mode
3. Calibration error indicator
4. Auto temperature compensation(ATC) or Manual temperature compensation(MTC)
5. Temperature reading and unit
6. unit of Conductivity or TDS reading

|   |   |
|---|---|
|  | <ol style="list-style-type: none"> <li>1. Turn on/off the controller</li> <li>2. Enter calibration mode</li> </ol>  |
|  | <ol style="list-style-type: none"> <li>1. Switch Conductivity and TDS mode</li> <li>2. Press and hold to enter setting mode</li> <li>3. In setting mode, press to store each setting</li> </ol> |
|  | <ol style="list-style-type: none"> <li>1. In measurement mode, adjust temperature value of MTC</li> </ol>   |
|  | <ol style="list-style-type: none"> <li>2. In setting mode, adjust each parameter</li> </ol>   |

## Calibration:

1. Switch mode to Conductivity mode.
2. Dip the conductivity cell and the temperature probe into the standard solution 1413  $\mu\text{S}/\text{cm}$ .
3. Stir gently and wait until the reading is stable.
4. Press and hold  for 3 sec. to enter calibration mode. The display will appear **CAL** and flashing 1413 $\mu\text{S}/\text{cm}$ . When the display stops flashing and indicates "**SA**", then "**End**" while calibration ends, and will return to measurement mode.







## Note:

Calibration error indicator icon will appear, and "**Err**" instead of "**SA**", if calibration fails.

## TDS converting ratio and temperature unit setting







TDS reading is converted from conductivity reading. The default ratio in this controller is 0.67

To change this ratio and temperature unit:

1. Switch mode to TDS mode.
2. Press and hold  until a beep sound, and then press  again.
3. The display will show the current TDS ratio. Press  to change the ratio from 0.50 to 1.00, and then press  to store the setting.
4. The display will then show the current temperature unit. Press  to change the type, and then press  to store the setting.

## 4-20mA output setting:

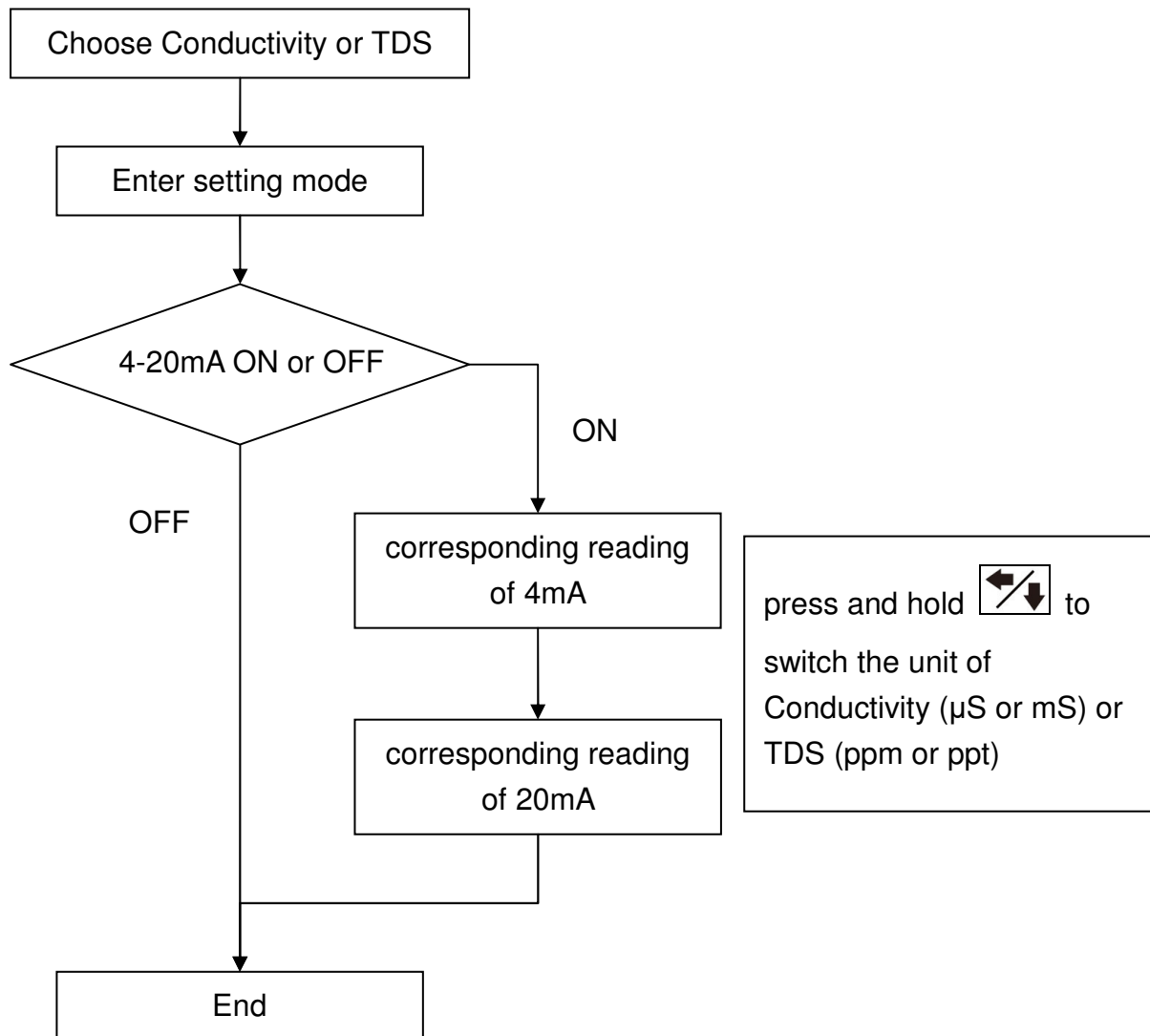

### < Programming the Setpoints and the Deadband >

1. Press  to choose Conductivity or TDS mode. The controller will store the settings for Conductivity and TDS separately.
2. Press and hold  button until a beep sound, and then press and hold  button until a beep sound to enter 4-20mA output setting mode.
3. Use  and  to adjust settings, and use  to store each setting.
4. The display will then automatically cycle through 3 settings: 4-20mA output on or off, the corresponding reading of 4mA, corresponding reading of 20mA.
5. When setting the corresponding readings, press and hold  to switch the unit of Conductivity ( $\mu\text{S}$  or  $\text{mS}$ ) or TDS (ppm or ppt).



## Other settings

### <Back light>

1. Press and hold  until a beep sound, release  and then press and hold  again.



2. Press  to choose On, OFF, and Auto:



On: back light is always on.

OFF: back light is always off.

Auto: back light will be on for 30 seconds while any button is pressed and then off.

### <Reset the controller to default setting>

1. Press and hold  until a beep sound, release  and then press and hold  again until a beep sound.

2. Press  to switch OFF to On, and then press  to reset the controller to default setting.